

TransPocket 150 TransPocket 180

Operating Instructions

EN

Rod electrode power source



42,0426,0203,EN 015-06042017

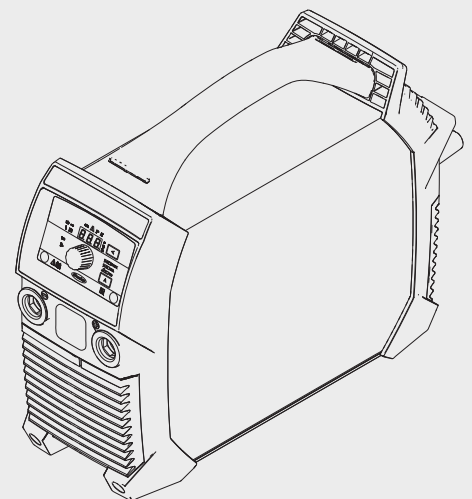

Dear reader,

Introduction

Thank you for the trust you have placed in our company and congratulations on buying this high-quality Fronius product. These instructions will help you familiarise yourself with the product. Reading the instructions carefully will enable you to learn about the many different features it has to offer. This will allow you to make full use of its advantages.

Please also note the safety rules to ensure greater safety when using the product. Careful handling of the product will repay you with years of safe and reliable operation. These are essential prerequisites for excellent results.

Contents

Safety rules	7
Explanation of safety symbols	7
General	7
Proper use	8
Environmental conditions	8
Obligations of the operator	8
Obligations of personnel	9
Mains connection	9
Residual current protective device	9
Protecting yourself and others	9
Noise emission values	10
Danger from toxic gases and vapours	10
Danger from flying sparks	11
Risks from mains current and welding current	11
Meandering welding currents	12
EMC Device Classifications	13
EMC measures	13
EMF measures	13
Specific hazards	14
Factors affecting welding results	15
Danger from shielding gas cylinders	15
Safety measures at the installation location and during transport	16
Safety measures in normal operation	16
Commissioning, maintenance and repair	17
Safety inspection	17
Disposal	17
Safety symbols	18
Data protection	18
Copyright	18
General	19
Device concept	19
Warning notices on the device	20
Application areas	21
Before commissioning	22
Safety	22
Proper use	22
Setup regulations	22
Generator-powered operation	22
Controls, connections and mechanical components	24
Safety	24
TransPocket 150 controls, connections and mechanical components	25
TransPocket 180 controls, connections and mechanical components	26
Control panel	27
MMA welding	28
Preparatory work	28
MMA welding	29
SoftStart / HotStart function	29
Arc-force dynamic	30
Pulse welding	30
TIG welding	32
General	32
Connecting the gas cylinder	32
Preparatory work	32
Setting the gas pressure - on the welding torch with gas cut-off valve	33
TIG welding	34
TIG Comfort Stop	34
Welding process Setup menu	36
Accessing the Setup menu	36
Changing welding parameters	36
Exiting the Setup menu	36

Parameters for MMA welding.....	36
Parameters for TIG welding.....	37
Setup menu - Level 2.....	39
Welding parameters in the level 2 Setup menu.....	39
Care, maintenance and disposal.....	41
Safety.....	41
General.....	41
At every start-up.....	41
Every 2 months.....	42
Disposal.....	42
Troubleshooting.....	43
Safety.....	43
Indicated errors.....	43
Service messages.....	43
No function.....	45
Faulty operation.....	45
Technical data.....	47
Explanation of the term "duty cycle".....	47
TransPocket 150.....	48
TransPocket 180.....	49
TransPocket 180 MV.....	50

Safety rules

Explanation of safety symbols



DANGER! Indicates immediate and real danger. If it is not avoided, death or serious injury will result.



WARNING! Indicates a potentially dangerous situation. Death or serious injury may result if appropriate precautions are not taken.



CAUTION! Indicates a situation where damage or injury could occur. If it is not avoided, minor injury and/or damage to property may result.



NOTE! Indicates a risk of flawed results and possible damage to the equipment.

IMPORTANT! Indicates tips for correct operation and other particularly useful information. It does not indicate a potentially damaging or dangerous situation.

If you see any of the symbols depicted in the "Safety rules" chapter, special care is required.

General



The device is manufactured using state-of-the-art technology and according to recognised safety standards. If used incorrectly or misused, however, it can cause:

- injury or death to the operator or a third party,
- damage to the device and other material assets belonging to the operating company,
- inefficient operation of the device.

All persons involved in commissioning, operating, maintaining and servicing the device must:

- be suitably qualified,
- have sufficient knowledge of welding and
- read and follow these operating instructions carefully.

The operating instructions must always be at hand wherever the device is being used. In addition to the operating instructions, attention must also be paid to any generally applicable and local regulations regarding accident prevention and environmental protection.

All safety and danger notices on the device

- must be in a legible state,
- must not be damaged,
- must not be removed,
- must not be covered, pasted or painted over.

For the location of the safety and danger notices on the device, refer to the section headed "General" in the operating instructions for the device. Before switching on the device, rectify any faults that could compromise safety.

This is for your personal safety!

Proper use



The device is to be used exclusively for its intended purpose.

The device is intended solely for the welding processes specified on the rating plate.

Any use above and beyond this purpose is deemed improper. The manufacturer shall not be held liable for any damage arising from such usage.

Proper use includes:

- carefully reading and following all the instructions given in the operating instructions
- studying and obeying all safety and danger notices carefully
- performing all stipulated inspection and maintenance work.

Never use the device for the following purposes:

- Thawing out pipes
- Charging batteries
- Starting engines

The device is designed for use in industry and the workshop. The manufacturer accepts no responsibility for any damage caused through use in a domestic setting.

The manufacturer likewise accepts no liability for inadequate or incorrect results.

Environmental conditions



Operation or storage of the device outside the stipulated area will be deemed as not in accordance with the intended purpose. The manufacturer shall not be held liable for any damage arising from such usage.

Ambient temperature range:

- during operation: -10 °C to + 40 °C (14 °F to 104 °F)
- during transport and storage: -20 °C to +55 °C (-4 °F to 131 °F)

Relative humidity:

- up to 50% at 40 °C (104 °F)
- up to 90% at 20 °C (68 °F)

The surrounding air must be free from dust, acids, corrosive gases or substances, etc.

Can be used at altitudes of up to 2000 m (6561 ft. 8.16 in.)

Obligations of the operator



The operator must only allow persons to work with the device who:

- are familiar with the fundamental instructions regarding safety at work and accident prevention and have been instructed in how to use the device
- have read and understood these operating instructions, especially the section "safety rules", and have confirmed as much with their signatures
- are trained to produce the required results.

Checks must be carried out at regular intervals to ensure that operators are working in a safety-conscious manner.

Obligations of personnel



Before using the device, all persons instructed to do so undertake:

- to observe the basic instructions regarding safety at work and accident prevention
- to read these operating instructions, especially the "Safety rules" section and sign to confirm that they have understood them and will follow them.

Before leaving the workplace, ensure that people or property cannot come to any harm in your absence.

Mains connection

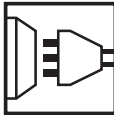

Devices with a higher rating may affect the energy quality of the mains due to their current consumption.

This may affect a number of types of device in terms of:

- connection restrictions
- criteria with regard to the maximum permissible mains impedance ^{*)}
- criteria with regard to the minimum short-circuit power requirement ^{*)}



^{*)} at the interface with the public grid
see Technical Data

In this case, the plant operator or the person using the device should check whether the device may be connected, where appropriate by discussing the matter with the power supply company.

 **NOTE!** Ensure that the mains connection is earthed properly

Residual current protective device



Local regulations and national guidelines may require a residual current protective device when connecting equipment to the public grid. The type of residual current protective device recommended by the manufacturer for the equipment is indicated in the technical data.

Protecting yourself and others



Persons involved with welding expose themselves to numerous risks, e.g.:

- flying sparks and hot pieces of metal
- arc radiation, which can damage eyes and skin



- hazardous electromagnetic fields, which can endanger the lives of those using cardiac pacemakers



- risk of electrocution from mains current and welding current



- greater noise pollution



-
- harmful welding fumes and gases
-

Anyone working on the workpiece while welding is in progress must wear suitable protective clothing with the following properties:

- flame-resistant
 - insulating and dry
 - covers the whole body, is undamaged and in good condition
 - safety helmet
 - trousers with no turn-ups
-



Protective clothing refers to a variety of different items. Operators should:

- protect eyes and face from UV rays, heat and sparks using a protective visor and regulation filter.
 - wear regulation protective goggles with side protection behind the protective visor.
 - wear stout footwear that provides insulation even in wet conditions.
 - protect the hands with suitable gloves (electrically insulated and providing protection against heat).
 - wear ear protection to reduce the harmful effects of noise and to prevent injury.
-



Keep all persons, especially children, out of the working area while any devices are in operation or welding is in progress. If, however, there are people in the vicinity,

- make them aware of all the dangers (risk of dazzling by the arc, injury from flying sparks, harmful welding fumes, noise, possible risks from mains current and welding current, etc.),
 - provide suitable protective equipment or
 - erect suitable safety screens/curtains.
-

Noise emission values



The device generates a maximum sound power level of <math><80\text{ dB(A)}</math> (ref. 1pW) when idling and in the cooling phase following operation at the maximum permissible operating point under maximum rated load conditions according to EN 60974-1.

It is not possible to provide a workplace-related emission value during welding (or cutting) as this is influenced by both the process and the environment. All manner of different welding parameters come into play, including the welding process (MIG/MAG, TIG welding), the type of power selected (DC or AC), the power range, the type of weld metal, the resonance characteristics of the workpiece, the workplace environment, etc.

Danger from toxic gases and vapours



The fumes produced during welding contain harmful gases and vapours.

Welding fumes contain substances that may, under certain circumstances, cause birth defects or cancer.

Keep your face away from welding fumes and gases.

Fumes and hazardous gases

- must not be breathed in
 - must be extracted from the working area using appropriate methods.
-

Ensure an adequate supply of fresh air with a ventilation rate of at least 20 m³/hour.

Otherwise, a protective mask with an air supply must be worn.

Close the shielding gas cylinder valve or main gas supply if no welding is taking place.

If there is any doubt about whether the extraction capacity is sufficient, the measured toxic emission values should be compared with the permissible limit values.

Amongst others, the following components are responsible for the degree of toxicity of welding fumes:

- Metals used for the workpiece
- Electrodes
- Coatings
- Cleaners, degreasers, etc.

The relevant material safety data sheets and manufacturer's specifications for the listed components should therefore be studied carefully.

Flammable vapours (e.g. solvent fumes) should be kept away from the arc's radiation area.

Danger from flying sparks



Flying sparks may cause fires or explosions.

Never weld close to flammable materials.

Flammable materials must be at least 11 metres (36 ft. 1.07 in.) away from the arc, or alternatively covered with an approved cover.

A suitable, tested fire extinguisher must be available and ready for use.

Sparks and pieces of hot metal may also get into adjacent areas through small gaps or openings. Take appropriate precautions to prevent any danger of injury or fire.

Welding must not be performed in areas that are subject to fire or explosion or near sealed tanks, vessels or pipes unless these have been prepared in accordance with the relevant national and international standards.

Do not carry out welding on containers that are being or have been used to store gases, propellants, mineral oils or similar products. Residues pose an explosive hazard.

Risks from mains current and welding current



An electric shock is potentially life threatening and can be fatal.

Do not touch live parts either inside or outside the device.



During MIG/MAG welding and TIG welding, the welding wire, the wirepool, the feed rollers and all pieces of metal that are in contact with the welding wire are live.

Always set the wirefeeder up on a sufficiently insulated surface or use a suitable, insulated wirefeeder holder.

Make sure that you and others are protected with an adequately insulated, dry temporary backing or cover for the earth or ground potential. This temporary backing or cover must extend over the entire area between the body and the earth or ground potential.

All cables and leads must be secured, undamaged, insulated and adequately dimensioned. Replace loose connections and scorched, damaged or inadequately dimensioned cables and leads immediately.

Use the handle to ensure the power connections are tight before every use. In the case of power cables with a bayonet connector, rotate the power cable around the longitudinal axis by at least 180° and pre-load.

Do not wrap cables or leads around the body or parts of the body.

The electrode (rod electrode, tungsten electrode, welding wire, etc.) must

- never be immersed in liquid for cooling
- Never touch the electrode when the power source is switched on.

Double the open circuit voltage of a power source can occur between the welding electrodes of two power sources. Touching the potentials of both electrodes at the same time may be fatal under certain circumstances.

Arrange for the mains cable to be checked regularly by a qualified electrician to ensure the ground conductor is functioning properly.

The device must only be operated on a mains supply with a ground conductor and a socket with a ground conductor contact.

Operating the device on a grid without a ground conductor and in a socket without a ground conductor contact will be deemed gross negligence. The manufacturer shall not be held liable for any damage arising from such usage.

If necessary, provide an adequate earth connection for the workpiece.

Switch off unused devices.

Wear a safety harness if working at height.

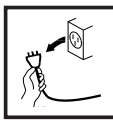

Before working on the device, switch it off and pull out the mains plug.

Attach a clearly legible and easy-to-understand warning sign to the device to prevent anyone from plugging the mains plug back in and switching it on again.

After opening the device:

- Discharge all live components
 - Ensure that all components in the device are de-energised
-

If work on live parts is required, appoint a second person to switch off the main switch at the right moment.

Meandering welding currents



If the following instructions are ignored, meandering welding currents can develop with the following consequences:

- Fire hazard
 - Overheating of parts connected to the workpiece
 - Irreparable damage to ground conductors
 - Damage to device and other electrical equipment
-

Ensure that the workpiece is held securely by the workpiece clamp.

Attach the workpiece clamp as close as possible to the area that is to be welded.

If the floor is electrically conductive, the device must be set up with sufficient insulating material to insulate it from the floor.

If distribution boards, twin-head mounts, etc., are being used, note the following: The electrode of the welding torch / electrode holder that is not used is also live. Make sure that the welding torch / electrode holder that is not used is kept sufficiently insulated.

In the case of automated MIG/MAG applications, ensure that only an insulated wire electrode is routed from the welding wire drum, large wirefeeder spool or wirepool to the wire-feed unit.

EMC Device Classifications



Devices in emission class A:

- Are only designed for use in industrial settings
- Can cause line-bound and radiated interference in other areas

Devices in emission class B:

- Satisfy the emissions criteria for residential and industrial areas. This is also true for residential areas in which the energy is supplied from the public low-voltage mains.

EMC device classification as per the rating plate or technical data.

EMC measures



In certain cases, even though a device complies with the standard limit values for emissions, it may affect the application area for which it was designed (e.g. when there is sensitive equipment at the same location, or if the site where the device is installed is close to either radio or television receivers).
If this is the case, then the operator is obliged to take appropriate action to rectify the situation.

Check and evaluate the immunity to interference of nearby devices according to national and international regulations. Examples of equipment that may be susceptible to interference from the device include:

- Safety devices
- Power, signal and data transfer lines
- IT and telecommunications devices
- Measuring and calibrating devices

Supporting measures for avoidance of EMC problems:

1. Mains supply
 - If electromagnetic interference arises despite correct mains connection, additional measures are necessary (e.g. use a suitable line filter).
2. Welding power leads
 - must be kept as short as possible
 - must run close together (to avoid EMF problems)
 - must be kept well apart from other leads
3. Equipotential bonding
4. Earthing of the workpiece
 - If necessary, establish an earth connection using suitable capacitors.
5. Shielding, if necessary
 - Shield off other nearby devices
 - Shield off entire welding installation

EMF measures



Electromagnetic fields may pose as yet unknown risks to health:

- effects on the health of others in the vicinity, e.g. wearers of pacemakers and hearing aids
- wearers of pacemakers must seek advice from their doctor before approaching the device or any welding that is in progress
- for safety reasons, keep distances between the welding cables and the welder's head/torso as large as possible
- do not carry welding cables and hosepacks over the shoulders or wind them around any part of the body

Specific hazards



Keep hands, hair, clothing and tools away from moving parts. For example:

- Fans
- Cogs
- Rollers
- Shafts
- Wirespools and welding wires

Do not reach into the rotating cogs of the wire drive or into rotating drive components.

Covers and side panels may only be opened/removed while maintenance or repair work is being carried out.

During operation

- Ensure that all covers are closed and all side panels are fitted properly.
- Keep all covers and side panels closed.



The welding wire emerging from the welding torch poses a high risk of injury (piercing of the hand, injuries to the face and eyes, etc.).



Therefore always keep the welding torch away from the body (devices with wire-feed unit) and wear suitable protective goggles.



Never touch the workpiece during or after welding - risk of burns.

Slag can jump off cooling workpieces. The specified protective equipment must therefore also be worn when reworking workpieces, and steps must be taken to ensure that other people are also adequately protected.

Welding torches and other parts with a high operating temperature must be allowed to cool down before handling.



Special provisions apply in areas at risk of fire or explosion - observe relevant national and international regulations.



Power sources for work in areas with increased electric risk (e.g. near boilers) must carry the "Safety" sign. However, the power source must not be located in such areas.



Risk of scalding from escaping coolant. Switch off cooling unit before disconnecting coolant flow or return lines.



Observe the information on the coolant safety data sheet when handling coolant. The coolant safety data sheet may be obtained from your service centre or downloaded from the manufacturer's website.



Use only suitable load-carrying equipment supplied by the manufacturer when transporting devices by crane.

- Hook chains and/or ropes onto all suspension points provided on the load-carrying equipment.
- Chains and ropes must be at the smallest angle possible to the vertical.
- Remove gas cylinder and wire-feed unit (MIG/MAG and TIG devices).

If the wire-feed unit is attached to a crane holder during welding, always use a suitable, insulated wirefeeder hoisting attachment (MIG/MAG and TIG devices).

If the device has a carrying strap or handle, this is intended solely for carrying by hand. The carrying strap is not to be used if transporting with a crane, counterbalanced lift truck or other mechanical hoist.

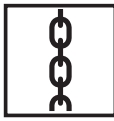

All lifting accessories (straps, handles, chains, etc.) used in connection with the device or its components must be tested regularly (e.g. for mechanical damage, corrosion or changes caused by other environmental factors). The testing interval and scope of testing must comply with applicable national standards and directives as a minimum.



Odourless and colourless shielding gas may escape unnoticed if an adapter is used for the shielding gas connection. Prior to assembly, seal the device-side thread of the adapter for the shielding gas connection using suitable Teflon tape.

Factors affecting welding results

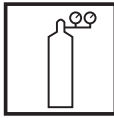

The following requirements with regard to shielding gas quality must be met if the welding system is to operate in a correct and safe manner:

- Size of solid matter particles < 40 µm
- Pressure dew point < -20 °C
- Max. oil content < 25 mg/m³

Filters must be used if necessary.



NOTE! There is an increased risk of soiling if ring mains are being used

Danger from shielding gas cylinders



Shielding gas cylinders contain gas under pressure and can explode if damaged. As the shielding gas cylinders are part of the welding equipment, they must be handled with the greatest of care.

Protect shielding gas cylinders containing compressed gas from excessive heat, mechanical impact, slag, naked flames, sparks and arcs.

Mount the shielding gas cylinders vertically and secure according to instructions to prevent them falling over.

Keep the shielding gas cylinders well away from any welding or other electrical circuits.

Never hang a welding torch on a shielding gas cylinder.

Never touch a shielding gas cylinder with an electrode.

Risk of explosion - never attempt to weld a pressurised shielding gas cylinder.

Only use shielding gas cylinders suitable for the application in hand, along with the correct and appropriate accessories (regulator, hoses and fittings). Only use shielding gas cylinders and accessories that are in good condition.

Turn your face to one side when opening the valve of a shielding gas cylinder.

Close the shielding gas cylinder valve if no welding is taking place.

If the shielding gas cylinder is not connected, leave the valve cap in place on the cylinder.

The manufacturer's instructions must be observed as well as applicable national and international regulations for shielding gas cylinders and accessories.

Safety measures at the installation location and during transport

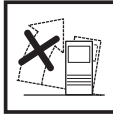

A device toppling over could easily kill someone. Place the device on a solid, level surface such that it remains stable

- The maximum permissible tilt angle is 10°.



Special regulations apply in rooms at risk of fire or explosion

- Observe relevant national and international regulations.

Use internal directives and checks to ensure that the workplace environment is always clean and clearly laid out.

Only set up and operate the device in accordance with the degree of protection shown on the rating plate.

When setting up the device, ensure there is an all-round clearance of 0.5 m (1 ft. 7.69 in.) to ensure that cooling air can flow in and escape unhindered.

When transporting the device, observe the relevant national and local guidelines and accident prevention regulations. This applies especially to guidelines regarding the risks arising during transport.

Before transporting the device, allow coolant to drain completely and detach the following components:

- Wire-feed unit
- Wirespool
- Shielding gas cylinder

After transporting the device, the device must be visually inspected for damage before commissioning. Any damage must be repaired by trained service technicians before commissioning the device.

Safety measures in normal operation



Only operate the device if all safety devices are fully functional. If the safety devices are not fully functional, there is a risk of

- injury or death to the operator or a third party,
- damage to the device and other material assets belonging to the operator,
- inefficient operation of the device.

Any safety devices that are not functioning properly must be repaired before switching on the device.

Never bypass or disable safety devices.

Before switching on the device, ensure that no one is likely to be endangered.

Check the device at least once a week for obvious damage and proper functioning of safety devices.

Always fasten the shielding gas cylinder securely and remove it beforehand if the device is to be transported by crane.

Only the manufacturer's original coolant is suitable for use with our devices due to its properties (electrical conductivity, anti-freeze agent, material compatibility, flammability, etc.).

Only use suitable original coolant from the manufacturer.

Do not mix the manufacturer's original coolant with other coolants.

The manufacturer accepts no liability for damage resulting from use of a different coolant. In addition, all warranty claims will be forfeited.

The coolant can ignite under certain conditions. Transport the coolant only in its original, sealed containers and keep well away from any sources of ignition.

Used coolant must be disposed of properly in accordance with the relevant national and international regulations. The coolant safety data sheet may be obtained from your service centre or downloaded from the manufacturer's website.

Check the coolant level before starting to weld and while the system is still cool.

Commissioning, maintenance and repair



It is impossible to guarantee that bought-in parts are designed and manufactured to meet the demands made of them, or that they satisfy safety requirements.

- Use only original spare and wearing parts (also applies to standard parts).
- Do not carry out any modifications, alterations, etc. to the device without the manufacturer's consent.
- Components that are not in perfect condition must be replaced immediately.
- When ordering, please give the exact designation and part number as shown in the spare parts list, as well as the serial number of your device.

The housing screws provide the ground conductor connection for earthing the housing parts.

Only use original housing screws in the correct number and tightened to the specified torque.

Safety inspection



The manufacturer recommends that a safety inspection of the device is performed at least once every 12 months.

The manufacturer recommends that the power source be calibrated during the same 12-month period.

A safety inspection should be carried out by a qualified electrician

- after any changes are made
- after any additional parts are installed, or after any conversions
- after repair, care and maintenance has been carried out
- at least every twelve months.

For safety inspections, follow the appropriate national and international standards and directives.

Further details on safety inspection and calibration can be obtained from your service centre. They will provide you on request with any documents you may require.

Disposal



Do not dispose of this device with normal domestic waste! To comply with the European Directive on Waste Electrical and Electronic Equipment and its implementation as national law, electrical equipment that has reached the end of its life must be collected separately and returned to an approved recycling facility. Any device that you no longer require must either be returned to your dealer or given to one of the approved collection and recycling facilities in your area. Ignoring this European Directive may have potentially adverse affects on the environment and your health!

Safety symbols



Devices with the CE mark satisfy the essential requirements of the low-voltage and electromagnetic compatibility directives (e.g. relevant product standards of the EN 60 974 series).

Fronius International GmbH hereby declares that the device is compliant with Directive 2014/53/EU. The full text on the EU Declaration of Conformity can be found at the following address: <http://www.fronius.com>



Devices marked with the CSA test mark satisfy the requirements of the relevant standards for Canada and the USA.

Data protection

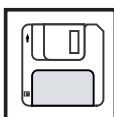

The user is responsible for the safekeeping of any changes made to the factory settings. The manufacturer accepts no liability for any deleted personal settings.

Copyright



Copyright of these operating instructions remains with the manufacturer.

The text and illustrations are all technically correct at the time of printing. We reserve the right to make changes. The contents of the operating instructions shall not provide the basis for any claims whatsoever on the part of the purchaser. If you have any suggestions for improvement, or can point out any mistakes that you have found in the instructions, we will be most grateful for your comments.

Device concept

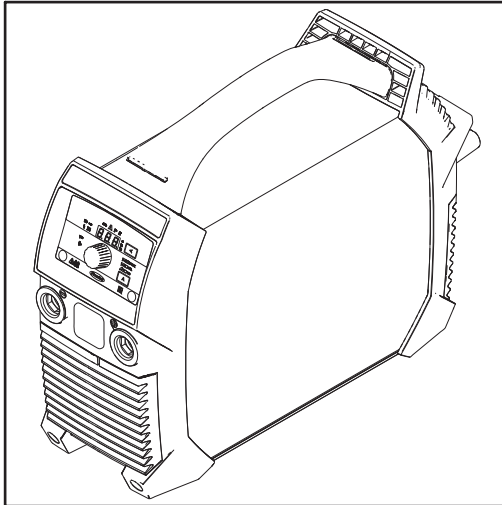

The power source has the following properties:

- Compact dimensions
- Robust plastic housing
- Extremely reliable even under harsh operating conditions
- Carrying strap for easy transport on construction sites, etc.
- Protected controls
- Current sockets with bayonet latch

In conjunction with the digital resonance inverter, an electronic regulator adapts the power source characteristic to suit the welding electrode during welding. The result is a light-weight and compact device with excellent ignition and weld properties.

The power source also features a Power Factor Correction, which adapts the current consumption of the power source to the sinusoidal mains voltage. This results in numerous advantages for the user, such as:

- Low primary current
- Low conduction losses
- Late tripping of the circuit breaker
- Improved stability in the event of voltage fluctuations
- Long mains leads can be used
- In the case of multivoltage devices, a continuous input voltage range

When using cellulose electrodes (CEL), a dedicated operating mode can be chosen for perfect welding results.

Warning notices on the device

The warning notices and safety symbols on the power source must not be removed or painted over. They warn against incorrect operation which can lead to serious injury and damage.

Meaning of safety symbols on the device:



Welding is dangerous. The following basic requirements must be met to ensure the equipment is used properly:

- Welders must be sufficiently qualified
- Suitable protective equipment must be used
- All persons not involved must be kept at a safe distance from the welding process









Do not use the functions described here until you have fully read and understood the following documents:

- these operating instructions
- all the operating instructions for the system components of the power source, especially the safety rules



Do not dispose of used devices with domestic waste. Dispose of them according to the safety rules.

⚠ WARNING			ARC RAYS can burn eyes and skin; NOISE can damage hearing. <ul style="list-style-type: none"> ● Wear welding helmet with correct filter. ● Wear correct eye, ear and body protection.
Do not Remove, Destroy, Or Cover This Label			
ARC WELDING can be hazardous. <ul style="list-style-type: none"> ● Read and follow all labels and the Owner's Manual carefully ● Only qualified persons are to install, operate, or service this unit according to all applicable codes and safety practices. ● Keep children away. ● Pacemaker wearers keep away. ● Welding wire and drive parts may be at welding voltage. 			EXPLODING PARTS can injure. <ul style="list-style-type: none"> ● Failed parts can explode or cause other parts to explode when power is applied. ● Always wear a face shield and long sleeves when servicing.
	ELECTRIC SHOCK can kill. <ul style="list-style-type: none"> ● Always wear dry insulating gloves. ● Insulate yourself from work and ground. ● Do not touch live electrical parts. ● Disconnect input power before servicing. ● Keep all panels and covers securely in place. 		ELECTRIC SHOCK can kill; SIGNIFICANT DC VOLTAGE exists after removal of input power <ul style="list-style-type: none"> ● Always wait 60 seconds after power is turned off before working on unit. ● Check input capacitor voltage, and be sure it is near 0 before touching parts.
		⚠ AVERTISSEMENT	
FUMES AND GASES can be hazardous. <ul style="list-style-type: none"> ● Keep your head out of the fumes. ● Ventilate area, or use breathing device. ● Read Material Safety Data Sheets (MSDSs) and manufacturer's instructions for materials used. 			UN CHOC ELECTRIQUE peut etre mortel. SOUDAGE A L'ARC peut etre hasardeux. <ul style="list-style-type: none"> ● Installation et raccordement de cette machine doivent etre conformes a tous les pertinents. ● Lire le manuel d'instructions avant utilisation. ● Ne pas installer sur une surface combustible. ● Les fils de soudage et pieces conductrices peuvent etre a la tension de soudage.
	WELDING can cause fire or explosion. <ul style="list-style-type: none"> ● Do not weld near flammable material. ● Watch for fire: keep extinguisher nearby. ● Do not locate unit over combustible surfaces. ● Do not weld on closed containers. 		
		Read American National Standard Z49.1, "Safety in Welding and Cutting". From American Welding Society, 550 N.W. LeJeune Rd., Miami, FL 33126; OSHA Safety and Health Standards, 29 CFR 1910, from U.S. Government Printing Office, Washington, DC 20402. CSA, W117-2 M87 Code for Safety in Welding and Cutting. 42.0409.5074	

Application areas

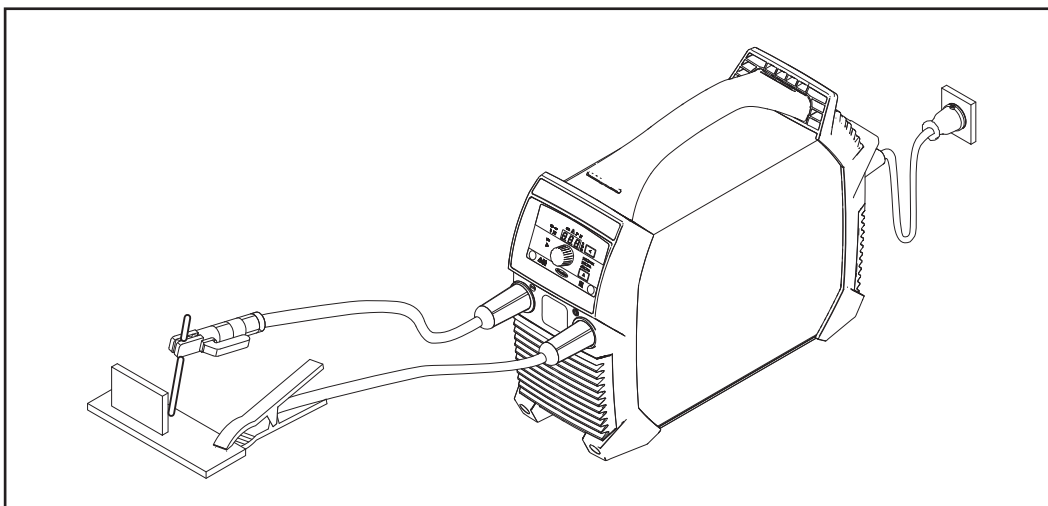

MMA welding

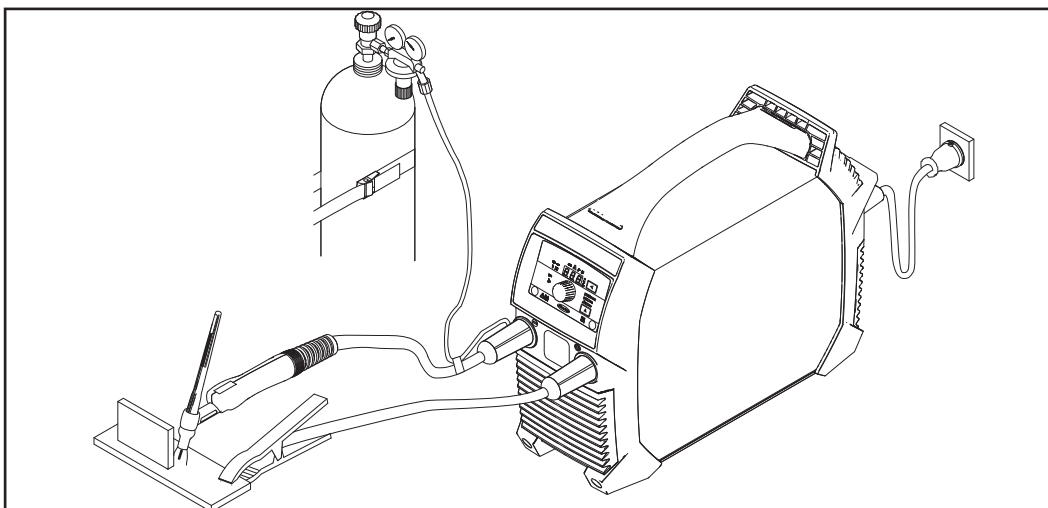

TIG welding, welding torch with gas cut-off valve

Before commissioning

Safety



WARNING! Incorrect operation or shoddy workmanship can cause serious injury or damage. All activities described in these operating instructions may only be carried out by trained and qualified personnel. All functions described in these operating instructions may only be used by trained and qualified personnel. Do not carry out any of the work or use any of the functions described until you have fully read and understood the following documents:

- these operating instructions
- all the operating instructions for the system components, especially the safety rules

Proper use

The power source is intended exclusively for MMA welding and TIG welding in conjunction with system components from Fronius.

Utilisation for any other purpose, or in any other manner, shall be deemed to be not in accordance with the intended purpose.

The manufacturer shall not be held liable for any damages arising from such usage.

Proper use also includes:

- carefully reading these operating instructions
- following all the instructions and safety rules in these operating instructions
- performing all stipulated inspection and maintenance work

Setup regulations



WARNING! Toppling or falling devices can cause life-threatening injuries. Place devices on a solid, level surface so that they remain stable.

The device is tested to IP 23 protection, meaning:

- protection against penetration by solid foreign bodies with diameters > 12.5 mm (0.49 in.)
- protection against direct sprays of water at any angle up to 60° from the vertical

Cooling air

The device must be set up in such a way that cooling air can flow freely through the slots in the front and rear panels.

Dust

Ensure that metallic dust is not sucked into the system by the fan, when carrying out grinding for example.

Outdoor operation

The device can be set up and operated outdoors in accordance with IP23 degree of protection. Avoid direct wetting (e.g. from rain).

Generator-powered operation

The power source is generator-compatible.

In order to dimension the required generator output, the maximum apparent power S_{1max} of the power source is required.

The maximum apparent power $S_{1\max}$ of the power source can be calculated as follows:

$$S_{1\max} = I_{1\max} \times U_1$$

See device rating plate or technical data for $I_{1\max}$ and U_1 values

The generator apparent power S_{GEN} needed is calculated using the following rule of thumb:

$$S_{\text{GEN}} = S_{1\max} \times 1.35$$

A smaller generator may be used when not welding at full power.

IMPORTANT! The generator apparent power S_{GEN} must always be higher than the maximum apparent power $S_{1\max}$ of the power source.

When using single-phase devices with a 3-phase generator, note that the specified generator apparent power is often only available as a whole across all three phases of the generator. If necessary, obtain further information on the single-phase power of the generator from the generator manufacturer.



NOTE! The voltage delivered by the generator must never exceed the upper or lower limits of the mains voltage tolerance range. Details of the mains voltage tolerance can be found in the "Technical data" section.

Controls, connections and mechanical components

Safety



WARNING! Operating the equipment incorrectly can cause serious injury and damage. Do not use the functions described until you have thoroughly read and understood the following documents:

- these operating instructions
- all the operating instructions for the system components, especially the safety rules



NOTE! Due to software updates, you may find that your device has certain functions that are not described in these operating instructions or vice versa. Individual illustrations may also differ slightly from the actual controls on your device, but these controls function in exactly the same way.

TransPocket 150 controls, connections and mechanical components

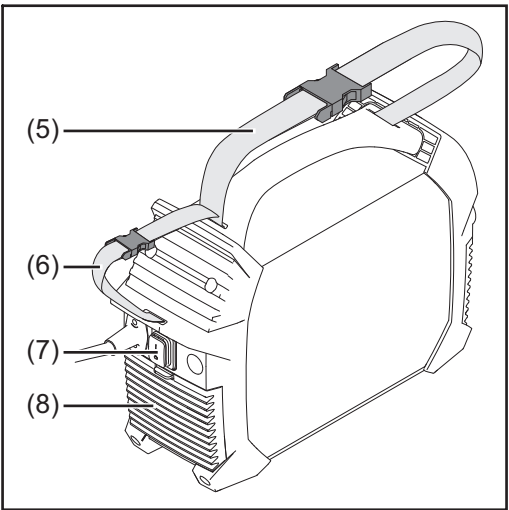
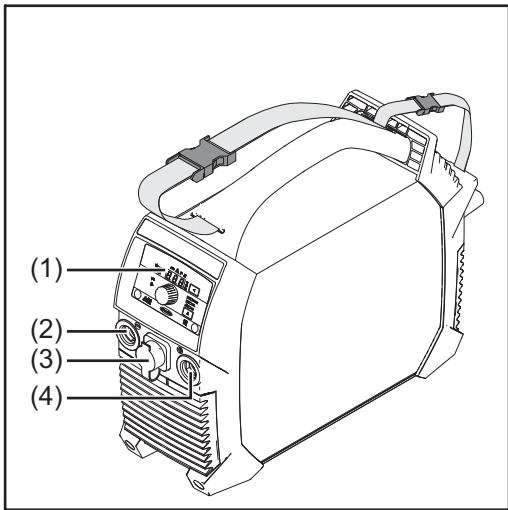

- (1) **Control panel**

- (2) **(-) current socket**
with bayonet latch

- (3) **TMC connection (TIG Multi Connector)**
TransPocket 150 RC only - for connecting a remote control

 **NOTE!** If a remote control is connected to the power source:

 - "rc" appears on the power source display
 - the welding current can only be adjusted using the remote control

- (4) **(+) current socket**
with bayonet latch

- (5) **Carrying strap**

- (6) **Cable strap**
for holding the mains cable and the welding power-leads
Do not use to move the device!

- (7) **Mains switch**

- (8) **Air filter**

Use of the current connections during manual metal arc welding (depending on electrode type):

- **(+) current socket** for electrode holder or grounding cable
- **(-) current socket** for electrode holder or grounding cable

Use of the current connections during TIG welding:

- **(+) current socket** for grounding cable
- **(-) current socket** for welding torch

**TransPocket 180
controls, connec-
tions and me-
chanical
components**

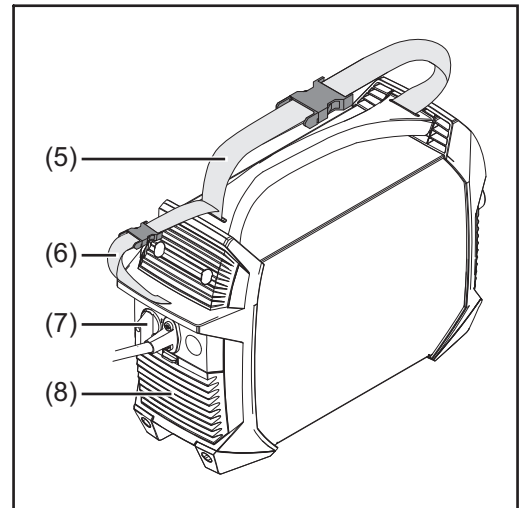
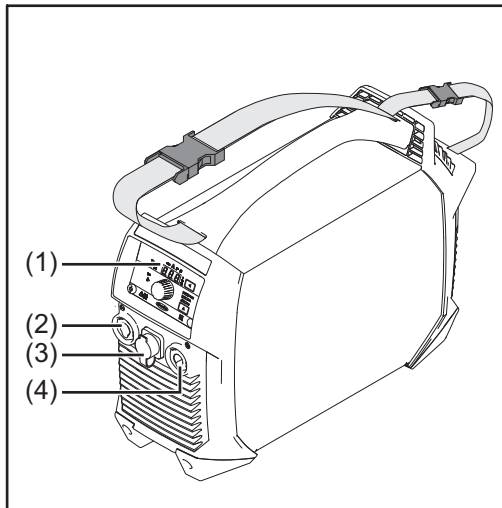

(1) **Control panel**

(2) **(-) current socket**
with bayonet latch

(3) **TMC connection (TIG Multi Connector)**
TransPocket 180 RC only - for connecting a remote control



NOTE! If a remote control is connected to the power source:

- "rc" appears on the power source display
- the welding current can only be adjusted using the remote control

(4) **(+) current socket**
with bayonet latch

(5) **Carrying strap**

(6) **Cable strap**
for holding the mains cable and the welding power-leads
Do not use to move the device!

(7) **Mains switch**

(8) **Air filter**

Use of the current connections during manual metal arc welding (depending on electrode type):

- **(+) current socket** for electrode holder or grounding cable
- **(-) current socket** for electrode holder or grounding cable

Use of the current connections during TIG welding:

- **(+) current socket** for grounding cable
- **(-) current socket** for welding torch

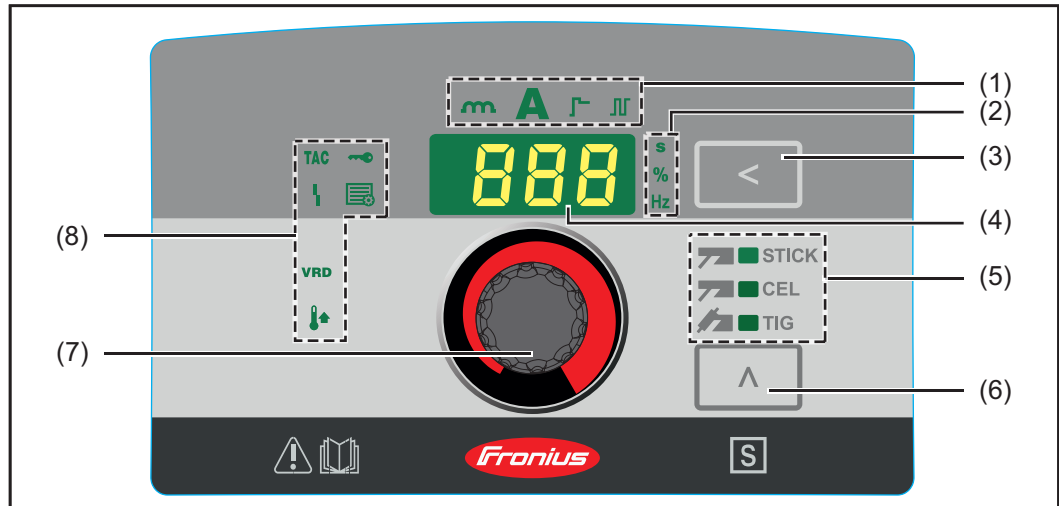

- (1) **Setting value indicator**
shows which setting value is selected:
- **m** Arc-force dynamic
 - **A** Welding current
 - **Γ** SoftStart / HotStart function
 - **Π** Pulse welding (only available for manual metal arc welding)
-
- (2) **Unit indicator**
shows the unit of the value that is currently being changed with the adjusting dial (7):
- **s** Time (seconds)
 - **%** Percent
 - **Hz** Frequency (Hertz)
-
- (3) **Setting value button**
for selecting the desired setting value (1)
-
- (4) **Display**
shows the current figure of the selected setting value
-
- (5) **Welding process indicator**
shows which welding process is selected:
- **STICK** MMA welding
 - **CEL** MMA welding with Cel electrode
 - **TIG** TIG welding
-
- (6) **Welding process button**
for selecting the welding process
-
- (7) **Adjusting dial**
for continuous adjustment of the selected setting value (1)
-
- (8) **Status indicators**
display various operating modes of the power source:
- **VRD** **VRD** - lights up when the safety device for voltage reduction is activated (VRD devices only)
 - **Setup** - lights up in Setup mode
 - **Temperature** - lights up when the device is outside the permissible temperature range
 - **Fault** - lights up in the event of a fault, also see section "Troubleshooting"
 - **TAC** **TAC** - lights up when the tacking function is activated (only on TIG devices with the TIG welding process)

MMA welding



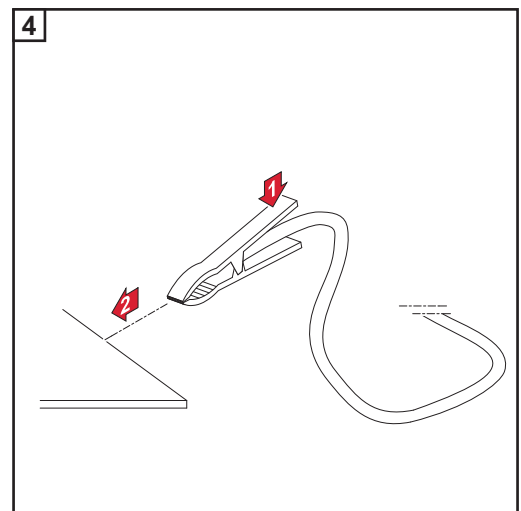
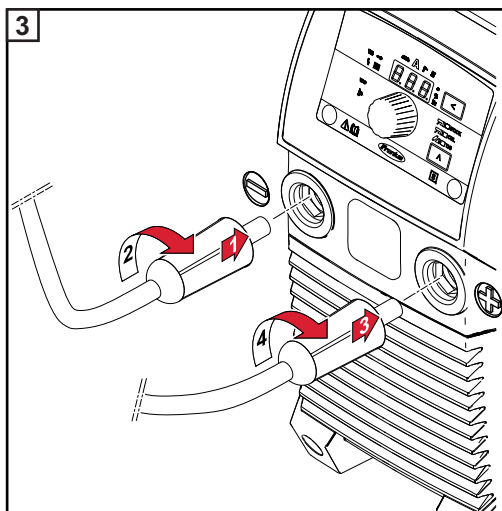
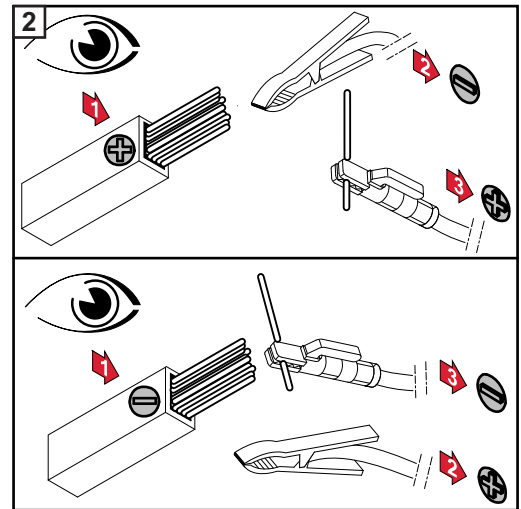
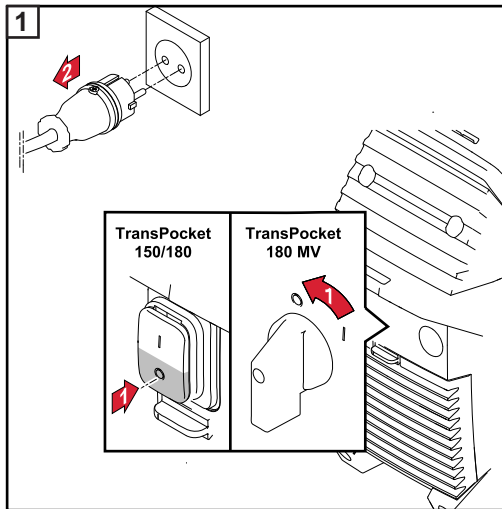

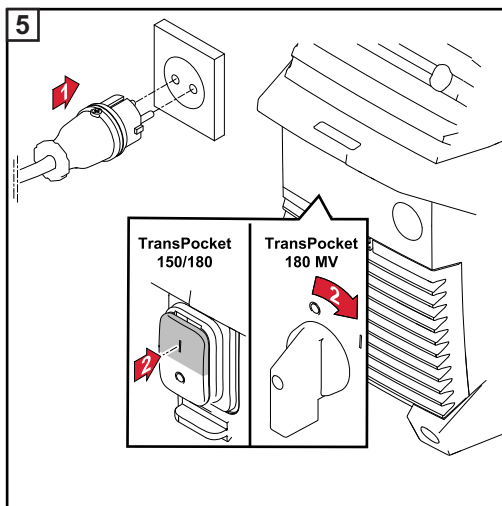

Preparatory work



CAUTION! Risk of injury and damage from electric shock. As soon as the power source is switched on, the electrode in the electrode holder is live. Make sure the electrode does not touch any persons or electrically conductive or earthed parts (e.g. the housing, etc.).



MMA welding

- 1  Use the welding process button to select one of the following processes:
 -  **STICK** MMA welding - the MMA welding indicator lights up after selection
 -  **CEL** MMA welding with Cel electrode - the MMA welding with Cel electrode indicator lights up after selection
- 2  Press the setting value button until  the welding current indicator lights up
- 3  Adjust the welding current using the adjusting dial
 - Power source is ready for welding

SoftStart / Hot-Start function

This function is used to set the starting current.

Setting range: 30 - 200%



Operating principle:

At the start of the welding process, the welding current is reduced (SoftStart) or increased (HotStart) for 0.5 seconds, depending on the setting.

The change is shown as a percentage from the set welding current.

The duration of the starting current can be changed in the Setup menu using the starting current duration (Hti) parameter.

Setting the starting current:

- 1  Press the setting value button until  the SoftStart / HotStart indicator lights up
- 2  Turn the adjusting dial until the desired value is reached
 - Power source is ready for welding



NOTE! The maximum HotStart current is limited as follows:

- TransPocket 150 to 160 A
- TransPocket 180 to 200 A

Examples (set welding current = 100 A):

- 100% \Rightarrow Starting current = 100 A \Rightarrow Function deactivated
- 80% \Rightarrow Starting current = 80 A \Rightarrow SoftStart
- 135% \Rightarrow Starting current = 135 A \Rightarrow HotStart
- 200% \Rightarrow Starting current, for TransPocket 150 = 160 A \Rightarrow HotStart (maximum current limit reached!)
- 200% \Rightarrow Starting current, for TransPocket 180 = 200 A \Rightarrow HotStart

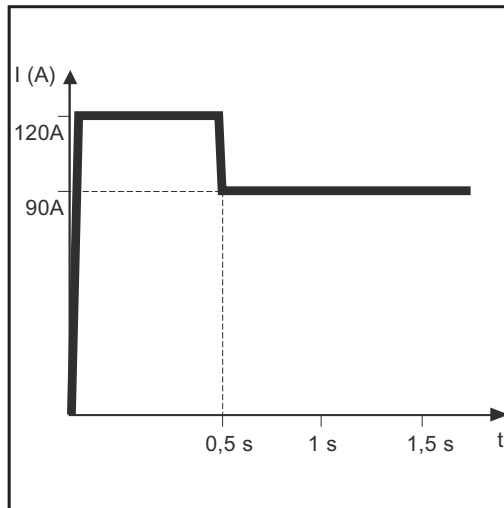

Example of HotStart function

Features of SoftStart function:

- Reduced pore formation with certain electrode types

Features of HotStart function:

- Improved ignition properties, even when using electrodes with poor ignition properties
- Better fusion of the base material during the start-up phase, meaning fewer cold-shut defects
- Largely prevents slag inclusions

Arc-force dynamic

To obtain optimum welding results, it will sometimes be necessary to adjust the arc-force dynamic.

Setting range: 0 - 100 (corresponds to 0 - 200 A current increase)

Operating principle:

At the moment of droplet transfer or in the event of a short circuit, the amperage is briefly increased in order to obtain a stable arc.

If the rod electrode threatens to sink into the weld pool, this measure prevents the weld pool solidifying, as well as preventing a prolonged short-circuit of the arc. This largely prevents the rod electrode from sticking.

Setting the arc-force dynamic:

1  Press the setting value button until the arc-force dynamic indicator lights up

2  Turn the adjusting dial until the desired correction value is reached

- Power source is ready for welding



NOTE! The maximum arc-force dynamic current is limited as follows:

- TransPocket 150 to 180 A
- TransPocket 180 to 220 A

Examples:

- Arc-force dynamic = 0
 - arc-force dynamic deactivated
 - soft, low-spatter arc
- Arc-force dynamic = 20
 - arc-force dynamic with 40 A current increase
 - harder, more stable arc
- Arc-force dynamic = 60, set welding current = 100 A
 - for the TransPocket 150: actual increase is just 80 A as the maximum current limit is reached!
 - for the TransPocket 180: arc-force dynamic with 120 A current increase

Pulse welding

Pulse welding is welding with a pulsing welding current. It is used for out-of-position welding of steel pipes or when welding thin sheets.

In these applications the welding current set at the start of welding is not always ideal for the whole welding process:

- if the amperage is too low, the base material will not melt sufficiently
- if overheating occurs, the liquid weld pool may drip.

Setting range: 0.5 - 100 Hz

Operating principle:

- A low base current I-G rises steeply to the significantly higher pulse current I-P and drops back to the base current I-G after the Duty cycle dcY time. The pulse current I-P can be set on the power source.
- This results in an average current that is lower than the set pulse current I-P.
- During pulse welding, small sections of the welding location melt quickly and then rapidly re-solidify.

NOTE! The power source controls the Duty cycle dcY parameter and base current I-G according to the set pulse current and pulse frequency.

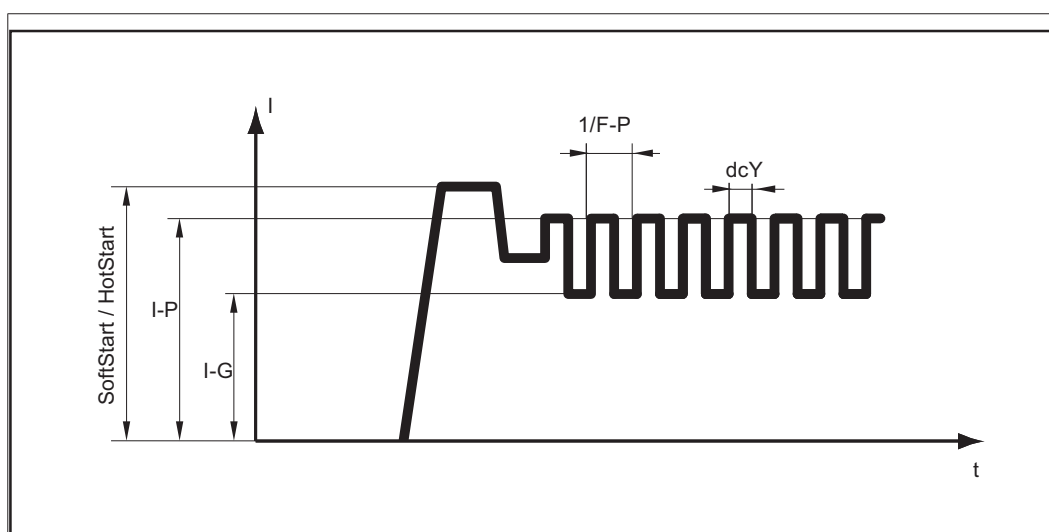

Pulse welding - welding current curve

Adjustable parameters:

F-P =	Pulse frequency (1/F-P = time interval between two pulses)	I-P =	Pulse current
SoftStart / HotStart			

Fixed parameters:

I-G =	Base current	dcY =	Duty cycle
-------	--------------	-------	------------

To use pulse welding:

- 1 Press the setting value button until the pulse welding indicator lights up
- 2 Turn the adjusting dial until the desired frequency value (Hz) is reached
 - Power source is ready for welding

TIG welding

General



NOTE! Do not use pure tungsten electrodes (colour-coded green) if the TIG welding process has been selected.

Connecting the gas cylinder



WARNING! There is a high risk of very serious injury and damage if a gas cylinder falls over. Place gas cylinders on a solid, level surface so that they remain stable. Secure gas cylinders to prevent them from falling over.

Observe the safety rules of the gas cylinder manufacturer.

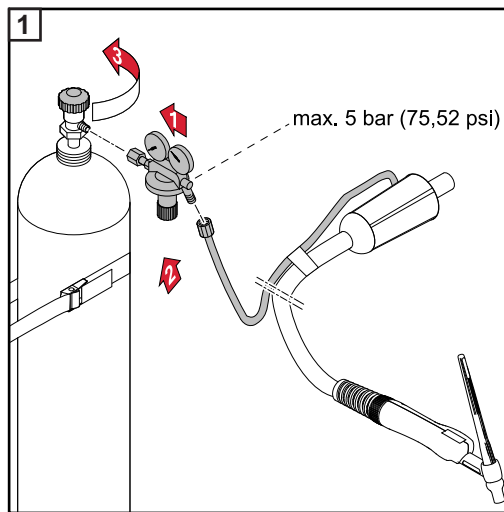

Preparatory work

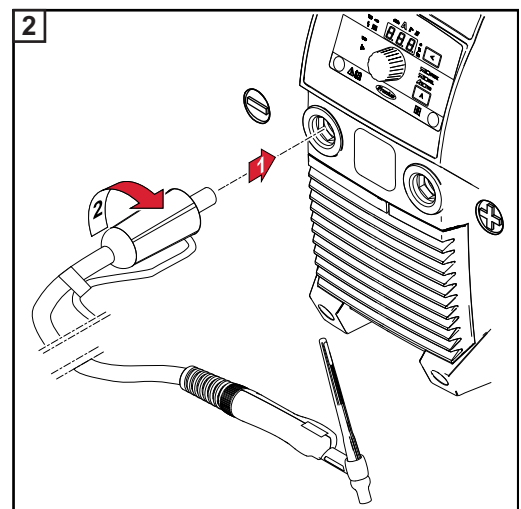
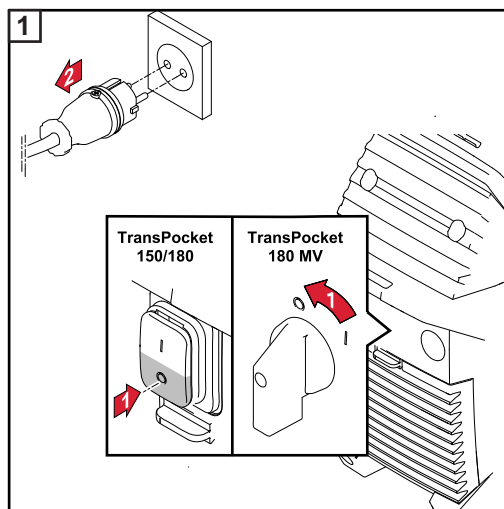

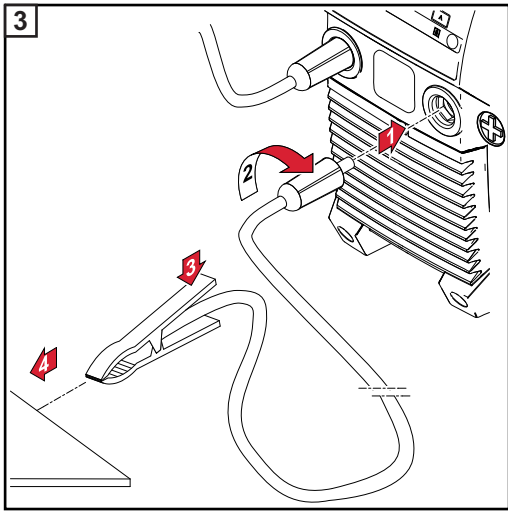

CAUTION! Risk of injury and damage from electric shock. As soon as the power source is switched on, the electrode in the welding torch is live. Make sure the electrode does not touch any persons or electrically conductive or earthed parts (e.g. the housing, etc.).

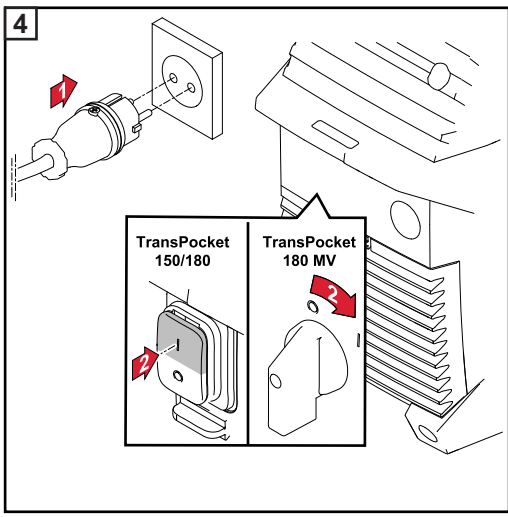



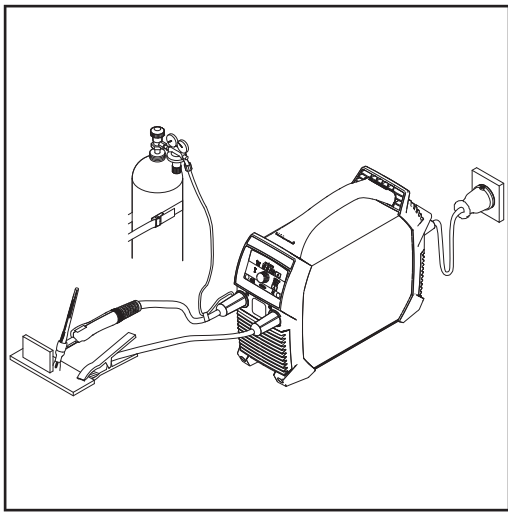

Setting the gas pressure - on the welding torch with gas cut-off valve



Welding torch with gas cut-off valve

- 1 Open the gas cut-off valve
– Shielding gas flows
- 2 Set the desired gas flow rate on the pressure regulator
- 3 Close the gas cut-off valve

TIG welding

- 1  Select TIG welding with the welding process button
 the TIG welding indicator lights up
- 2  Press the setting value button until
 the welding current indicator lights up
- 3  Adjust the welding current using the adjusting dial
- 4 Place the gas nozzle down on the ignition location, ensuring there is a gap of approx. 2 to 3 mm (5/64 to 1/8 in.) between the tungsten electrode and the workpiece
- 5 Actuate the gas cut-off valve
 - Shielding gas flows
- 6 Gradually tilt the welding torch up until the tungsten electrode touches the workpiece
- 7 Raise the welding torch and rotate it into its normal position
 - The arc ignites
- 8 Carry out welding

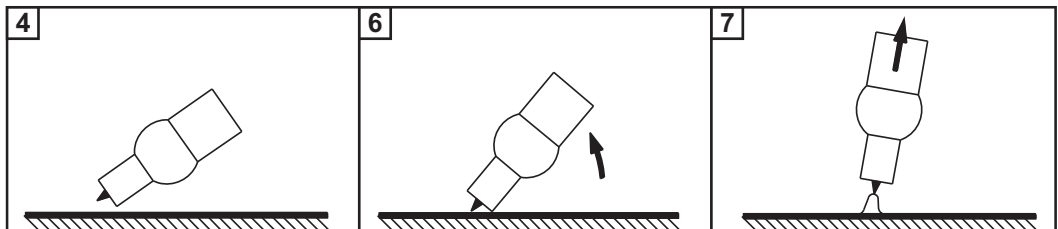

TIG Comfort Stop



NOTE! To enable and set the TIG Comfort Stop function, see the description of the "Comfort Stop Sensitivity" (Comfort Stop Sensitivity) parameter in the "Welding process Setup menu" section.

Operating principle and use of the TIG Comfort Stop:

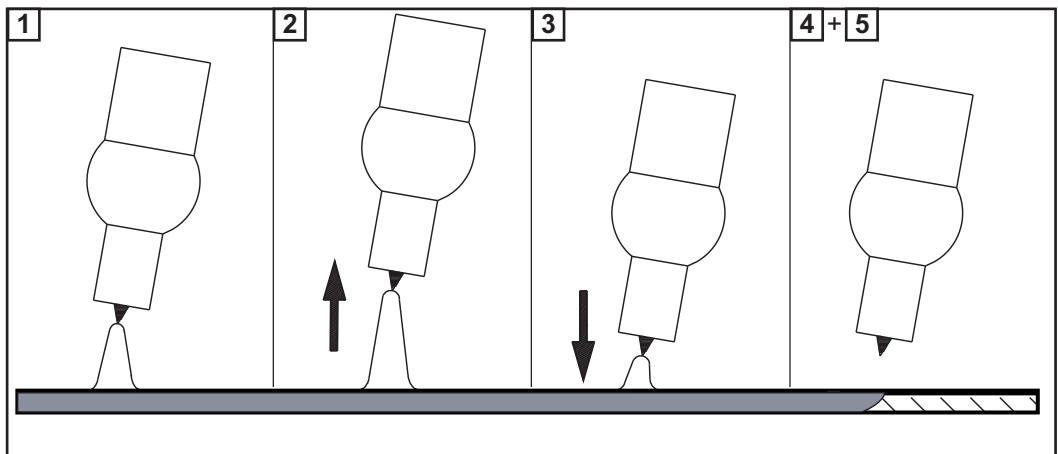

- 1 Welding
- 2 During welding, raise the welding torch
 - The arc length is increased significantly
- 3 Lower the welding torch
 - The arc length is decreased significantly
 - The TIG Comfort Stop function is activated
- 4 Keep the welding torch at the same height
 - The welding current continually decreases (DownSlope) until the arc goes out

- 5 Wait for the gas post-flow time to finish and lift the welding torch away from the work-piece

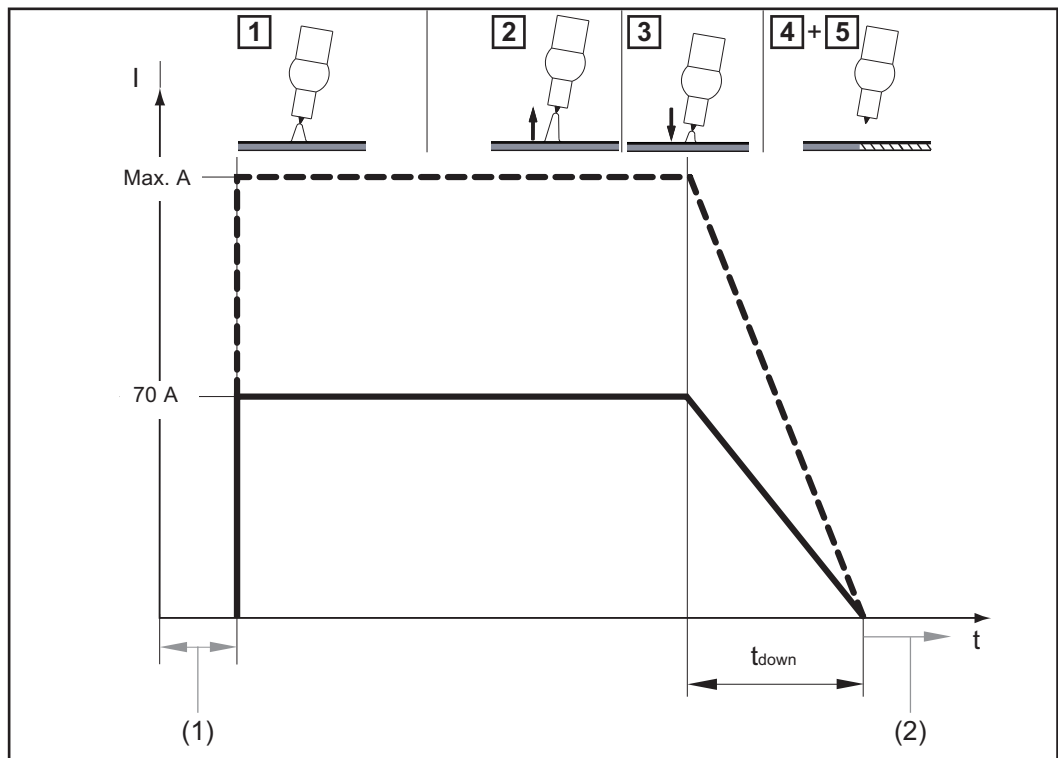

Welding current and gas flow curve with TIG Comfort Stop function activated

- (1) Gas pre-flow
(2) Gas post-flow

DownSlope:

The DownSlope time t_{down} is 0.5 seconds and cannot be adjusted.

Gas post-flow:

The gas post-flow must be carried out manually.

Welding process Setup menu

Accessing the Setup menu

- 1  Use the Welding Process button to select the process whose Setup parameters are to be changed:





 **STICK** MMA welding

 **CEL** MMA welding with Cel electrode



 **TIG** TIG welding

- 2  Press the Setting Value and Welding Process buttons together
 - The code for the first parameter in the Setup menu is displayed on the control panel



Changing welding parameters





- 1  Turn the adjusting dial to select the required parameter
- 2  Press the adjusting dial to display the preset value of the parameter
- 3  Turn the adjusting dial to change the value
 - The new value becomes effective immediately
 - Exception: when restoring the factory settings, press the adjusting dial after changing the value to activate the new value.
- 4  Press the adjusting dial to return to the list of parameters

Exiting the Setup menu



- 1  Press the Setting Value or  Press the Welding Process button to exit the Setup menu



Parameters for MMA welding

Parameter	Description	Range	Unit
	Starting current duration For the SoftStart / HotStart function Factory setting: 0.5 seconds	0.1 - 1.5	Seconds
	Anti-stick When the anti-stick function is active, the arc is extinguished after 1.5 seconds in the event of a short circuit (sticking of the electrode) Factory setting: ON (activated)		On OFF
	Str For activating / deactivating the start ramp Factory setting: ON (activated)		On OFF

Parameter	Description	Range	Unit
	Break voltage (U cut off) Used to specify at which arc length the welding process is completed. The welding voltage increases as the length of the arc increases. The arc is extinguished when it reaches the voltage specified here Factory setting: 45 volts	25 - 90	Volts
	Factory setting (FACTory) This can be used to reset the device to its factory settings <ul style="list-style-type: none"> - Cancel reset No - Reset the parameters for the selected welding process to their factory settings YES - Reset the parameters for all welding processes to their factory settings ALL  Resetting of the selected value to its factory setting must be confirmed by pressing the adjusting dial.		
	Level 2 Setup menu For setting general parameters For details, see section "Level 2 Setup menu"		



Parameters for TIG welding

Parameter	Description	Range	Unit
	Comfort Stop Sensitivity (Comfort Stop Sensitivity) Factory setting on TransPocket 150: 1.6 volts Factory setting on TransPocket 180: 1.5 volts For details, see section „TIG Comfort Stop“	OFF 0.5 - 2.5	Volts
	Break voltage (U cut off) Used to specify at which arc length the welding process is completed. The welding voltage increases as the length of the arc increases. The arc is extinguished when it reaches the voltage specified here This parameter is only available when the CSS parameter is set to OFF Factory setting: 15 volts	12 - 22	Volts

Parameter	Description	Range	Unit
	Factory setting (FACTory) This can be used to reset the device to its factory settings <ul style="list-style-type: none"> - Cancel reset - Reset the parameters for the selected welding process to their factory settings - Reset the parameters for all welding processes to their factory settings  Resetting of the selected value to its factory setting must be confirmed by pressing the adjusting dial.	No YES ALL	
	Level 2 Setup menu For setting general parameters For details, see section "Level 2 Setup menu"		

Setup menu - Level 2



Welding parameters in the level 2 Setup menu

Parameter	Description	Range	Unit
	Software version The full version number of the currently installed software is spread across a number of displays and can be retrieved by turning the adjusting dial		
	Automatic switch-off (time Shut down) If the device is not used or operated for a specified period of time, it automatically switches itself into Standby mode Pressing any button on the control panel will cancel Standby mode and the device will be ready to resume welding Factory setting: OFF	5 - 60 OFF	Minutes
	Fuse For displaying/setting the fuse used Factory setting: - For mains voltage 230 V = 16 A - For mains voltage 120 V = 20 A If a fuse is set on the power source, the power source limits the power drawn from the mains. This prevents the circuit breaker from tripping immediately	At 230 V: 10 / 13 / 16 / OFF (TP 180 MV only) At 120 V: 15 / 16 / 20 / OFF (TP 180 MV only)	Amperes

Mains voltage	Set fuse	Welding current electrode	TIG welding current	Duty cycle
230 V	10 A	110 A	150 A	35%
	13 A	130 A	150 A	35%
	16 A	150 A	150 A	35%

TransPocket 180 - Ratio between set fuse and welding current:				
Mains voltage	Set fuse	Welding current electrode	TIG welding current	Duty cycle
230 V	10 A	125 A	180 A	40%
	13 A	150 A	200 A	40%
	16 A	180 A	220 A	40%
120 V*	OFF (TP 180 MV only)	180 A	220 A	40%
	15 A	85 A	130 A	40%
	16 A	95 A	140 A	40%
	20 A (TP 180 MV only)	120 A	170 A	40%
	OFF (TP 180 MV only)	120 A	170 A	40%

* Depending on the triggering characteristic of the circuit breaker, the full duty cycle of 40% cannot be achieved on 120 V grids (e.g. USA circuit breaker type CH -15% D.C.).

Parameter	Description	Range	Unit
	<p>System on time</p> <p>For displaying the operating time (begins to count as soon as the device is switched on)</p> <p>The full operating time is spread across a number of displays and can be retrieved by turning the adjusting dial</p>		Hours, minutes, seconds
	<p>System Active time</p> <p>For displaying how long the system has been active for (only shows the time during which welding was in progress)</p> <p>The full system active time is spread across a number of displays and can be retrieved by turning the adjusting dial</p>		Hours, minutes, seconds

Care, maintenance and disposal

Safety



WARNING! Work that is carried out incorrectly can cause serious injury and damage. All the work described below must only be carried out by trained and qualified personnel. Do not carry out any of the work described below until you have fully read and understood the following documents:

- This document
- all the operating instructions for the system components, especially the safety rules



WARNING! An electric shock can be fatal. Before starting the work described below:

- Turn the power source mains switch to the "O" position
- Disconnect the power source from the mains
- Ensure that the power source remains disconnected from the mains until all work has been completed

After opening the device, use a suitable measuring instrument to check that electrically charged components (e.g. capacitors) have been discharged.



WARNING! An inadequate ground conductor connection can cause serious injury or damage. The housing screws provide a suitable ground conductor connection for grounding the housing and must NOT be replaced by any other screws that do not provide a reliable ground conductor connection.

General

Under normal operating conditions, the device requires only a minimum of care and maintenance. However, it is vital to observe some important points to ensure the device remains in a usable condition for many years.

At every start-up

- Ensure that the mains plug and mains cable as well as the welding torch / electrode holder are undamaged. Replace any damaged components
- Ensure that a proper ground earth connection has been established to the workpiece
- Check that there is an all-round clearance of 0.5 m (1 ft. 8 in.) around the device to ensure that cooling air can flow in and out freely



NOTE! Air inlets and outlets must never be covered, not even partially.

Every 2 months

Clean air filter:

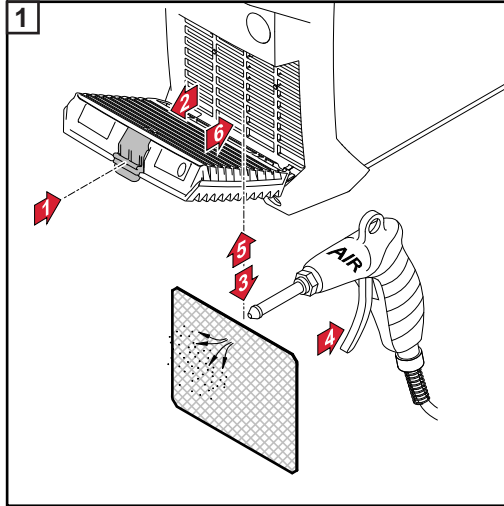

Disposal

Dispose of in accordance with the applicable national and local regulations.

Troubleshooting

Safety



WARNING! Work that is carried out incorrectly can cause serious injury and damage. All the work described below must only be carried out by trained and qualified personnel. Do not carry out any of the work described below until you have fully read and understood the following documents:

- This document
- all the operating instructions for the system components, especially the safety rules



WARNING! An electric shock can be fatal. Before starting the work described below:

- Turn the power source mains switch to the "O" position
- Disconnect the power source from the mains
- Ensure that the power source remains disconnected from the mains until all work has been completed

After opening the device, use a suitable measuring instrument to check that electrically charged components (e.g. capacitors) have been discharged.



WARNING! An inadequate ground conductor connection can cause serious injury or damage. The housing screws provide a suitable ground conductor connection for grounding the housing and must NOT be replaced by any other screws that do not provide a reliable ground conductor connection.

Indicated errors

Overtemperature

"hot" appears in the display, the "Temperature" indicator lights up



Cause: Operating temperature too high

Remedy: Allow device to cool (do not switch off the device - the fan will cool it down)

Service messages

When E and a 2 digit error number appear in the display (e.g. E02) and the "Error" indicator lights up, this is an internal power source service code.

Example: 



It is also possible that several error numbers are present. These appear when turning the adjusting dial.

Make a note of the error numbers shown in the display, and of the serial number and configuration of the power source, and contact our after-sales service team with a detailed description of the error.

E01 - E03 / E11 / E15 / E21 / E33 - E35 / E37 - E40 / E42 - E44 / E46 - E52

Cause: Fault in power module

Remedy: Contact After-Sales Service

E04

Cause: Open circuit voltage is not being reached:
electrode in contact with workpiece / hardware fault

Remedy: Remove electrode holder from workpiece. If the service code continues to be displayed, contact after-sales service

E05 / E06 / E12

Cause: System start-up failed

Remedy: Switch device off and on again. Contact after-sales service if a repeated occurrence

E10

Cause: Overvoltage at the current socket ($> 113 V_{DC}$)

Remedy: Contact after-sales service

E16 / E17

Cause: Memory fault

Remedy: Contact After-Sales Service / Press adjusting dial to acknowledge the service message



NOTE! On standard variants of the device, acknowledging the service message has no effect on the availability of power source functions. On all other variants (TIG, etc.), only a restricted range of functions is available after acknowledging the message. Contact After-Sales Service to have the full functionality restored.

E19

Cause: Overtemperature or undertemperature

Remedy: Operate the device in permitted ambient temperatures. For more details on environmental conditions, see "Environmental conditions" in the "Safety rules" section

E20

Cause: Improper use of the device

Remedy: Only use the device for its intended purpose

E22

Cause: Welding current set too high

Remedy: Ensure that the power source is being operated on the correct mains voltage; ensure that the correct fuse is set; set a lower welding current

E37

Cause: Mains voltage too high

Remedy: Pull out the mains plug immediately; ensure that the power source is being operated on the correct mains voltage

E36, E41, E45

Cause: Mains voltage outside tolerance or maximum load of grid is too low

Remedy: Ensure that the power source is being operated on the correct mains voltage; ensure that the correct fuse is set;

E65 - E75

Cause: Communication error with welding torch/remote control

Remedy: Check TIG Multi Connector plug connection / switch device off and on again / contact after-sales service if a repeated occurrence

No function**The device cannot be switched on**

Cause: Mains switch is faulty
 Remedy: Contact After-Sales Service

No welding current

Power source is switched on, indicator for the selected welding process is lit

Cause: Welding power-lead connections have been disconnected
 Remedy: Establish proper welding power-lead connections

Cause: Poor or no earth
 Remedy: Establish a connection to the workpiece

Cause: There is a break in the power cable in the welding torch or electrode holder
 Remedy: Replace welding torch or electrode holder

No welding current

Device switched on, indicator for the selected welding process is lit, overtemperature indicator lit

Cause: Duty cycle exceeded - device overloaded - fan running
 Remedy: Keep within duty cycle

Cause: Thermostatic automatic circuit breaker has switched off the device
 Remedy: Wait until the power source comes back on automatically at the end of the cooling phase (do not switch off the device - the fan will cool it down)

Cause: The fan in the power source is faulty
 Remedy: Contact After-Sales Service

Cause: Insufficient cooling air intake
 Remedy: Ensure adequate air supply

Cause: Air filter is dirty
 Remedy: Clean air filter

Cause: Power module error
 Remedy: Turn off the device, then turn it on again
 If the error occurs frequently, contact After-Sales Service

Faulty operation**Poor ignition properties during MMA welding**

Cause: Incorrect welding process selected
 Remedy: Select "MMA welding" or "MMA welding with Cel electrode" process

Cause: Starting current too low; electrode sticking during ignition
 Remedy: Increase starting current using HotStart function

Cause: Starting current too high; electrode consumed too quickly during ignition or is generating a lot of spatter
 Remedy: Reduce starting current using SoftStart function

In some cases, arc breaks during welding

Cause: Break voltage (Uco) set too low

Remedy: Increase break voltage (Uco) in Setup menu

Cause: Electrode (e.g. grooved electrode) voltage too high

Remedy: If possible, use an alternative electrode or a power source with more welding power

Rod electrode tends to stick

Cause: Value of arc-force dynamic parameter (MMA welding) set too low

Remedy: Increase value of arc-force dynamic parameter

Poor weld properties

(severe spattering)

Cause: Incorrect electrode polarity

Remedy: Reverse electrode polarity (refer to manufacturer's instructions)

Cause: Poor grounding (earthing) connection

Remedy: Fasten earthing clamps directly to workpiece

Cause: Setup parameters not ideal for selected welding process

Remedy: Select the optimal settings in the Setup menu for the selected welding process

Tungsten electrode melting

Tungsten inclusions in base metal during the ignition phase

Cause: Incorrect tungsten electrode polarity

Remedy: Connect the TIG welding torch to the (-) current socket

Cause: Incorrect (or no) shielding gas

Remedy: Use inert shielding gas (argon)

Technical data

Explanation of the term "duty cycle"

Duty cycle (D.C.) is the proportion of time in a 10-minute cycle at which the device may be operated at its rated output without overheating.



NOTE! The D.C. values specified on the rating plate are based on an ambient temperature of 40°C. If the ambient temperature is higher, either the D.C. or output must be reduced accordingly.

Example: Welding at 150 A at 60% D.C.

- Welding phase = 60% of 10 minutes = 6 minutes
- Cooling phase = remaining time = 4 minutes
- After the cooling phase, the cycle begins anew.

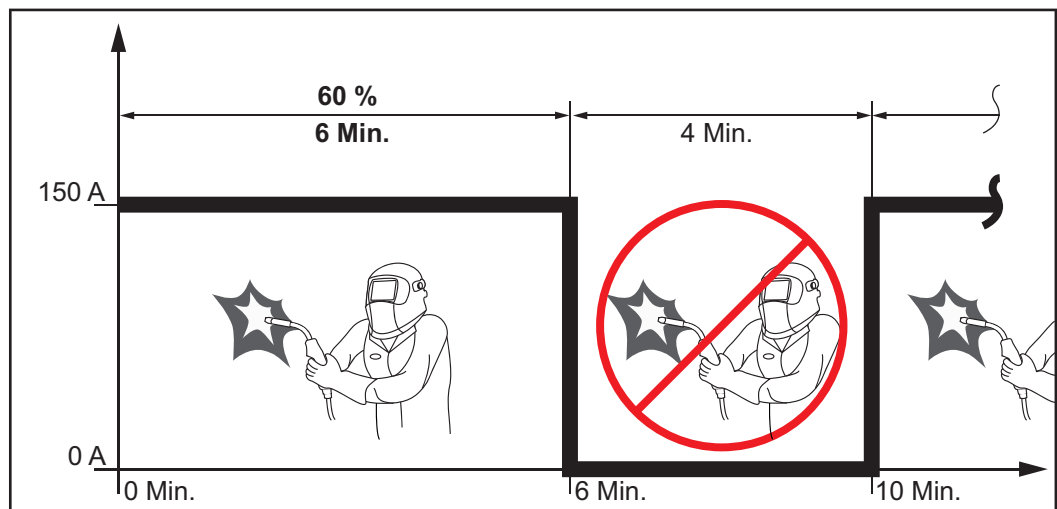

If the device is to be continuously operated without stopping:

- 1 look in the technical data for a D.C. value of 100% for the reigning ambient temperature.
- 2 Reduce the output or amperage in line with this value so that the device can remain in use without observing a cooling phase.

**TransPocket
150**

Mains voltage (U_1)	1 x 230 V			
Max. effective primary current ($I_{1\text{eff}}$)	15 A			
Max. primary current ($I_{1\text{max}}$)	24 A			
Max. apparent power ($S_{1\text{max}}$)	5.52 kVA			
Mains fuse protection	16 A slow-blow			
Mains voltage tolerance	-20%/+15%			
Mains frequency	50 / 60 Hz			
Cos phi	0.99			
Max. permissible mains impedance Z_{max} on PCC ¹⁾	32 mOhm			
Recommended earth-leakage circuit breaker	Type B			
Welding current range (I_2)				
MMA	10 - 150 A			
TIG	10 - 150 A			
Welding current for MMA welding	10 min/40 °C (104 °F)	35%	60%	100%
		150 A	110 A	90A
Welding current for TIG welding	10 min/40 °C (104 °F)	35%	60%	100%
		150 A	110 A	90A
Output voltage range according to standard characteristic (U_2)				
MMA	20.4 - 26.0 V			
TIG	10.4 - 16.0 V			
Open circuit voltage (U_0 peak)	96 V			
Efficiency at 90 A / 23.6 V	88%			
Degree of protection	IP 23			
Type of cooling	AF			
Overvoltage category	III			
Pollution level according to IEC60664	3			
EMC device class	A			
Safety symbols	S, CE			
Dimensions l x w x h	365 x 130 x 285 mm 14.4 x 5.1 x 11.2 in.			
Weight	6.3 kg 13.9 lb.			

1) Interface to a 230/400 V, 50 Hz public grid

**TransPocket
180**

Mains voltage (U_1)	1 x 230 V			
Max. effective primary current ($I_{1\text{eff}}$)	16 A			
Max. primary current ($I_{1\text{max}}$)	25 A			
Max. apparent power ($S_{1\text{max}}$)	5.75 kVA			
Mains fuse protection	16 A slow-blow			
Mains voltage tolerance	-20%/+15%			
Mains frequency	50 / 60 Hz			
Cos phi	0.99			
Max. permissible mains impedance Z_{max} on PCC ¹⁾	285 mOhm			
Recommended earth-leakage circuit breaker	Type B			
Welding current range (I_2)				
MMA	10 - 180 A			
TIG	10 - 220 A			
Welding current for MMA welding	10 min/40 °C (104 °F)	40%	60%	100%
		180 A	150 A	120 A
Welding current for TIG welding	10 min/40 °C (104 °F)	40%	60%	100%
		220 A	150 A	120 A
Output voltage range according to standard characteristic (U_2)				
MMA	20.4 - 27.2 V			
TIG	10.4 - 18.8 V			
Open circuit voltage (U_0 peak)	101 V			
Efficiency at 120 A / 24.8 V	89%			
Degree of protection	IP 23			
Type of cooling	AF			
Overvoltage category	III			
Pollution level according to IEC60664	3			
EMC device class	A			
Safety symbols	S, CE			
Dimensions l x w x h	435 x 160 x 310 mm 17.1 x 6.3 x 12.2 in.			
Weight	8.7 kg 19.3 lb.			

1) Interface to a 230/400 V, 50 Hz public grid

**TransPocket
180 MV**

Mains voltage (U_1)	1 x 230 V			
Max. effective primary current (I_{1eff})	16 A			
Max. primary current (I_{1max})	25 A			
Max. apparent power (S_{1max})	5.75 kVA			
Mains fuse protection	16 A slow-blow			
<hr/>				
Mains voltage (U_1)	1 x 120 V			
Max. effective primary current (I_{1eff})	20 A			
Max. primary current (I_{1max})	28 A			
Max. apparent power (S_{1max})	3.48 kVA			
Mains fuse protection	20 A slow-blow			
<hr/>				
Mains voltage (U_1)	1 x 120 V			
Max. effective primary current (I_{1eff})	15 A			
Max. primary current (I_{1max})	19 A			
Max. apparent power (S_{1max})	2.28 kVA			
Mains fuse protection	15 A slow-blow			
<hr/>				
Mains voltage tolerance	-20%/+15%			
Mains frequency	50 / 60 Hz			
Cos phi	0.99			
Max. permissible mains impedance Z_{max} on PCC ¹⁾	285 mOhm			
Recommended earth-leakage circuit breaker	Type B			
<hr/>				
Welding current range (I_2), $U_1 = 230$ V				
MMA	10 - 180 A			
TIG	10 - 220 A			
<hr/>				
Welding current range (I_2), $U_1 = 120$ V, fuse = 20 A				
MMA	10 - 120 A			
TIG	10 - 170 A			
<hr/>				
Welding current range (I_2), $U_1 = 120$ V, fuse = 15 A				
MMA	10 - 85 A			
TIG	10 - 140 A			
<hr/>				
Welding current for MMA welding	10 min/40 °C (104 °F)	40%	60%	100%
($U_1 = 230$ V, fuse = 16 A)		180 A	150 A	120 A
<hr/>				
Welding current for TIG welding	10 min/40 °C (104 °F)	40%	60%	100%
($U_1 = 230$ V, fuse = 16 A)		220 A	160 A	130 A
<hr/>				

Welding current for MMA welding ($U_1 = 120 \text{ V}$, fuse = 20 A)	10 min/40 °C (104 °F)	40% 120 A	60% 100 A	100% 90 A
Welding current for TIG welding ($U_1 = 120 \text{ V}$, fuse = 20 A)	10 min/40 °C (104 °F)	40% 170 A	60% 130 A	100% 100 A
Welding current for MMA welding ($U_1 = 120 \text{ V}$, fuse = 15 A)	10 min/40 °C (104 °F)	40% 85 A	60% 70 A	100% 65 A
Welding current for TIG welding ($U_1 = 120 \text{ V}$, fuse = 15 A)	10 min/40 °C (104 °F)	40% 140 A	60% 110 A	100% 100 A
Output voltage range according to standard characteristic (U_2)				
MMA				20.4 - 27.2 V
TIG				10.4 - 18.8 V
Open circuit voltage (U_0 peak)				101 V
Efficiency at 120 A / 24.8 V (230 V)				89%
Efficiency at 90 A / 23.6 V (120 V)				86%
Efficiency at 65 A / 22.6 V (120 V)				86%
Degree of protection				IP 23
Type of cooling				AF
Overvoltage category				III
Pollution level according to IEC60664				3
EMC device class				A
Safety symbols				S, CE
Dimensions l x w x h				435 x 160 x 310 mm 17.1 x 6.3 x 12.2 in.
Weight excluding mains cable				8.3 kg 18.4 lb.
Weight including mains cable				8.9 kg 19.6 lb.

1) Interface to a 230/400 V, 50 Hz public grid



FRONIUS INTERNATIONAL GMBH

Froniusplatz 1, A-4600 Wels, Austria

Tel: +43 (0)7242 241-0, Fax: +43 (0)7242 241-3940

E-Mail: sales@fronius.com

www.fronius.com

www.fronius.com/addresses

Under <http://www.fronius.com/addresses> you will find all addresses
of our Sales & service partners and Locations